

The AZEK Tapered Column Wrap should be installed using the same good building principles used to install wood trim and mouldings and in accordance with the local building codes and guidelines included below. These products may not be suitable for every application and it is the installer's sole responsibility to ensure they are fit for the intended use. AZEK Exteriors accepts no liability or responsibility for the improper installation of this product. AZEK Exteriors assumes no responsibility for moisture infiltration. If you have questions or need further assistance, please call AZEK Customer Service at 877-ASK-AZEK (275-2935) or visit [www.AZEKexteriors.com](http://www.AZEKexteriors.com).

### REQUIRED TOOLS FOR INSTALL

The Tapered Column Wrap is designed for easy, straightforward installation with standard woodworking tools.

**YOU WILL NEED THE FOLLOWING TOOLS:**

- Power saw or woodworking handsaw
- Rubber mallet
- Measuring tape
- Phillips drill bit head and or screwdriver
- Carpenters level
- Pencil

**ADDITIONAL REQUIREMENTS**

- PVC Adhesive
- 1-1/2# Wood Screws (8)
- 3/8" Conicals (4)

### REQUIRED TOOLS FOR INSTALL

Please note: the Tapered Column Wrap is a decorative column only and is non-load bearing. If the column needs to support any weight, a sufficient load bearing structural post must be in place before installation begins.

**Step 1** Begin by opening the cardboard packaging and unfolding it to create a protective surface.

- Step 2**
- A. Position the bottom squaring corners at the desired location around your structure.
  - B. Mark the center of the two squaring corners on adjacent sides. Run a level from the center mark of the bottom squaring corner of both adjacent sides to the top of the beam where the top squaring corner will be positioned.
  - C. Once the positions of the squaring corners have been measured and marked, fasten one top squaring corner into the predetermined position.

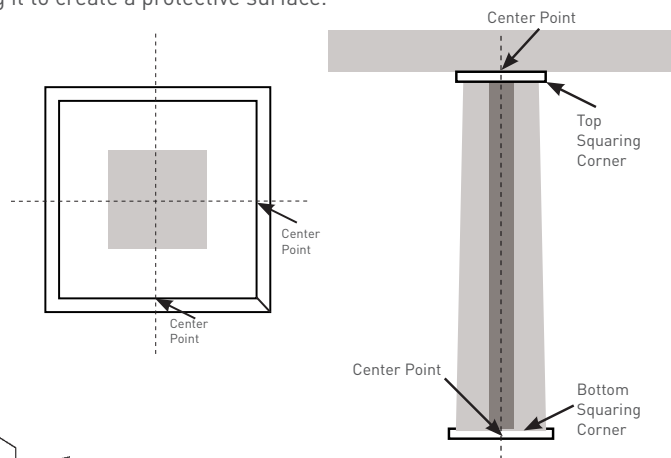

- Step 3** Measure height and cut column shaft 1/4" shorter for expansion/contraction. **IMPORTANT: ONLY CUT FROM BOTTOM!** Bottom skirts may be resized for a shorter column, but the top cannot. You can cut all four (4) shaft panels at one time.

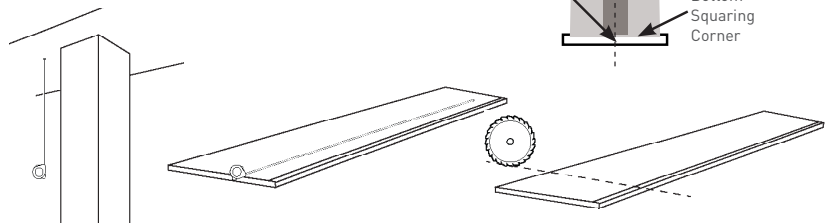

- Step 4** Lay one (1) panel with a female locking joint laying on the cardboard box. Apply PVC adhesive down the lock grooves on either side, and assemble three (3) column shaft sides by pressing male locking joints into matched female sides.

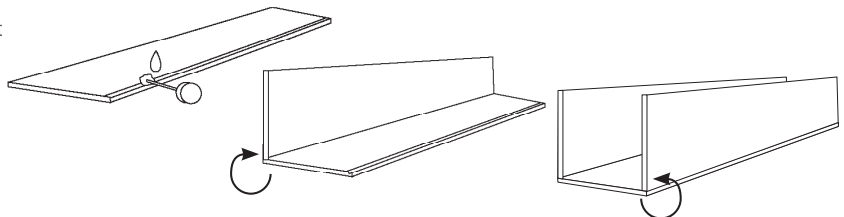

**Step 5**

Position the 3-sided column into the top squaring corner.

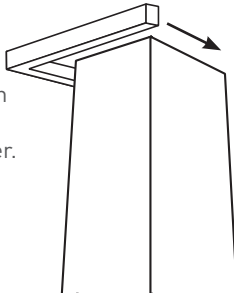

**Step 6**

Position the column into the bottom squaring corner.

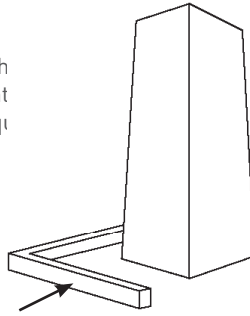

**Step 7**

Place the last shaft panel on the cardboard and apply PVC adhesive down each locking joint groove.

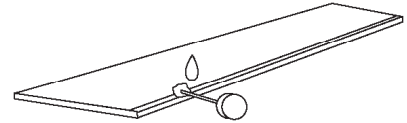

**Step 8**

Align the last column shaft panel into position. Using a rubber mallet, tap the panel to fit tightly.

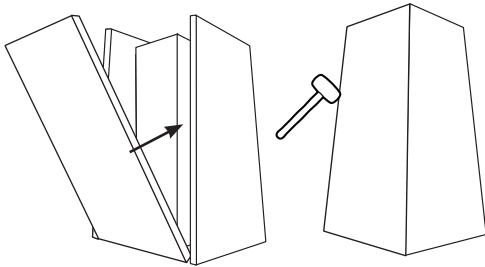

**Step 9**

Fasten the remaining squaring corners into place at the top and bottom. Be sure to use PVC adhesive on one half of each miter.

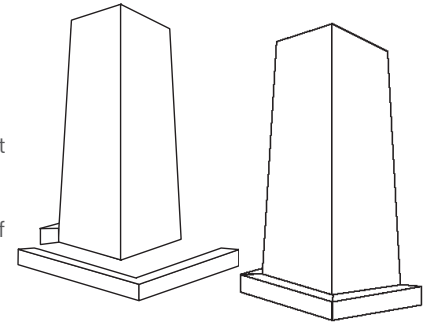

**INSTALLATION INSTRUCTIONS SKIRT ACCESSORY**

The optional decorative cap and base included will add depth and beauty to your Tapered Column. Follow the steps below for installing both parts of the system. If you have cut the bottom of the column shaft panels, read Resizing Bottom Skirt for Cut Shaft Panels below before proceeding. NOTE: the tape adhesive bonds instantly and permanently, so proper positioning is essential to ensure a good fit.

**Resizing Bottom Skirt for Cut Shaft Panels**

Before proceeding with the steps below, hold the skirt panels in final install positions to mark for cutting. Mark and cut at a 45° angle. It may be easier to cut panels 2 and 3 with a knife and install as two-piece sections. Be sure to pull off the blue support tape, which can be reused to hold miters together without the need for external fasteners.

1. Take the backing off the adhesive strips on panels 1, 2 and 4. Keep the strips on panel 3 to allow for positioning.

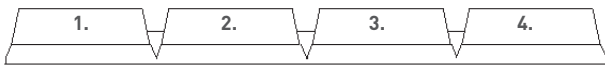

2. Apply PVC adhesive to one half of each miter.

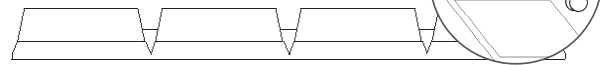

3. Fold panels 1 and 4 on to the back of panels 2 and 3, then form a 90° corner.

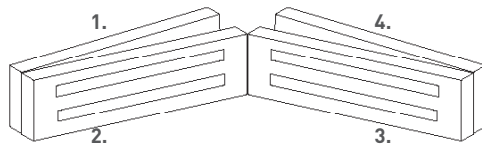

4. Slide on panel 3 backing position skirt until panel 2 makes contact, then remove backing from panel 3 adhesive strips and press into position.

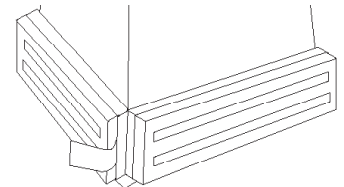

5. Unfold panels 1 and 4 into final positions. Note that the extra blue support tape can be used to hold the last corner together.

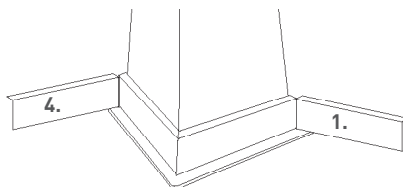

6. The bottom skirt is now complete. Repeat these steps for the top skirt and remove support tape once the PVC glue is set.

